

PNEUMATIC SCALE ANGELUS SEAMER TOOLING

WHY CHOOSE OUR SEAMER TOOLING?

Pneumatic Scale Angelus offers the best expertise, knowledge and recognition in the Seaming Industry.

We are a recognized leader in the design, production and maintenance of high speed can seaming equipment. For over 100 years, we have led the way in developing Seaming Rolls & Tooling and making them for your canning/cannery business. No other company can offer the expertise, knowledge and recognition in the Seaming Industry.

Advantages of our seamer tooling

- Fewer seamer adjustments to compensate for wear in bearings or profiles;
- Fewer stops to lubricate the rolls;
- Increased number of cans closed;
- Reduced time spent on seamer tooling changes;
- More consistent double seam quality;
- Standardization of seamer tooling and double seam specifications.

Our people

We aim to work proactively, in partnership with your organization, which is why we have full-time Service Specialists to work with you. We carefully match Seaming Rolls & Tooling to meet your business needs. These specialists have in-depth knowledge of your business and can match our Seaming Rolls & Tooling perfectly to fit your requirements.

Training

Our comprehensive range of training courses support and complement your business needs at every step along your route to certification.

Quality Control

Pneumatic Scale Angelus has the highest standard for quality control. We are committed to provide defect-free products and services that satisfy the requirements of our customers on time, every time. Parts are inspected at each stage of production. All critical dimensions are inspected 100% prior to shipment.



Our designers and engineers are continuously developing better ways to increase the performance and reliability of our tooling, so that our customers can increase their productivity.



USA | AUSTRALIA | BELGIUM | CANADA | HONG KONG | UNITED KINGDOM | CHINA | ITALY



SEAMING ROLLS

- Material:
 - AISI 440C (corrosion resistant steel)
 - ANGELLOY® (Cobalt Alloy)
 - D-2
- Design:
 - Specific to each seamer type
- Bearing:
 - Needle roller
 - Taper roller
 - Ceramic
- Coating:
 - CVD Titanium Nitride
 - CVD Titanium Carbide
 - PVD
 - Alternative special application coatings available

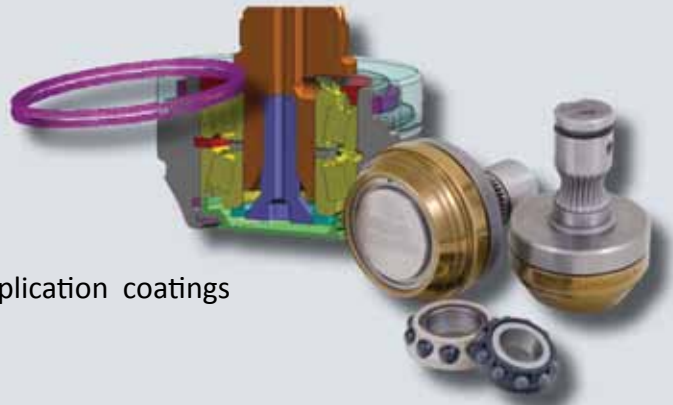

PSA provides the highest quality of seaming rolls and a variety of styles to meet your business application.

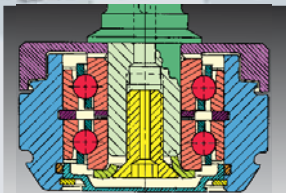

Angular Contact Bearing with Ceramic Balls

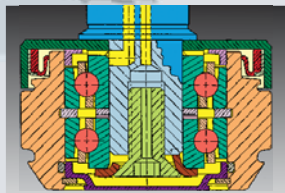

Flow-Thru Lubrication with Ceramic Balls

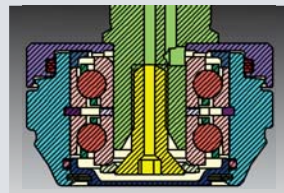

Flow-Thru Lubrication with Ceramic Balls and Labyrinth Seal

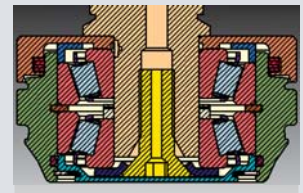

Flow-Thru Lubrication with Tapered Roller and Labyrinth Seal

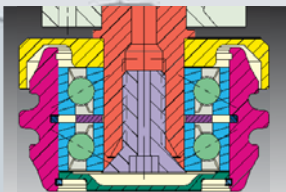

Double Groove Seaming Rolls

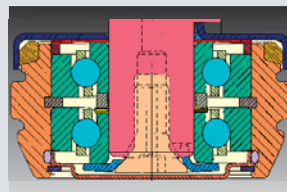

Non Flow-Thru Lubrication with Ceramic Balls

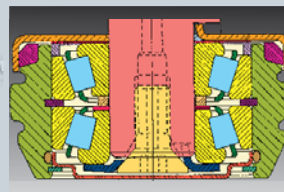

Non Flow-Thru Lubrication with Tapered Roller

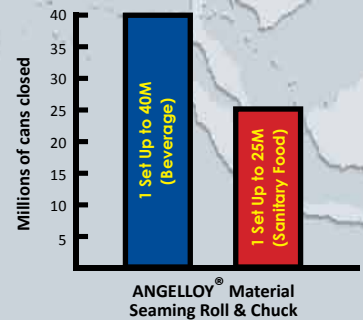

ANGELLOY® is a unique and top quality Cobalt Alloy material specifically for seamer tooling application etc.

SEAMING CHUCKS

- AISI 440A/C (corrosion resistant steel)
- ANGELLOY® non interlocking
- Available coated or non-coated (CVD process) & PVD coating
- Available textured or non-textured chuck lip
- Seaming chucks are designed and manufactured for compatibility with the seaming roll specifications
- Our Seaming Chucks & Rolls are made of material consisting of either Cobalt Alloy, Stainless Steel or Cromovan. We offer non-coating or 100% coating process with Titanium Nitride or Titanium Carbide or customer preferred type coating.

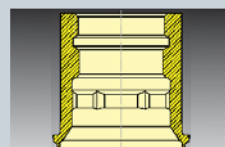
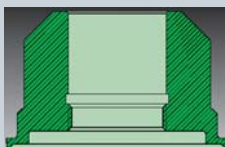
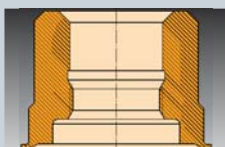
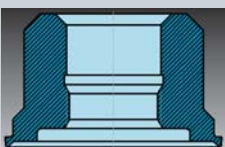

Seaming rolls and chucks can be ordered for any type of seamer made in the world today such as: Ferrum, CFT, Cevolani, Comaco, Sima, Zacmi, Lubeca, FMC, JBT, Metal Box, Somme, Manzini, Lanico, ecc.